



MARCA DA QUALIDADE

/Ferragens / Alumínio / Puxadores

Rua Juraci Aletto, 224 - Galpão B - Sertãozinho - Mauá - SP
Fone: (11) 2137-7300 | www.alindustria.com.br



/ALINDUSTRIA



@ALINDUSTRIA



IMPORTANTE:

A INSTALAÇÃO DO KIT BOX DEVERÁ SER FEITA SOMENTE POR PROFISSIONAIS QUALIFICADOS, COM EXPERIÊNCIA EM INSTALAÇÕES COM VIDRO TEMPERADO.

A AL INDÚSTRIA NÃO SE RESPONSABILIZA POR EVENTUAIS DANOS CAUSADOS POR FALTA DE MANUTENÇÃO* E POR USO INADEQUADO* (*CONSULTE: MANUAL DE UTILIZAÇÃO, LIMPEZA E MANUTENÇÃO DOS BOXES DE BANHEIRO).

NÃO SERÁ CONCEDIDA GARANTIA QUANDO FOR CONSTATADO MÁ INSTALAÇÃO, VIOLAÇÕES, DESMONTES, CONSERTO EFETUADOS POR PESSOAS NÃO QUALIFICADAS, E AINDA: DANOS CAUSADOS POR AGENTES DA NATUREZA, ACIDENTES E NEGLIGÊNCIAS DE QUALQUER ESPÉCIE.



MARCA DA QUALIDADE

/Ferragens / Alumínio / Puxadores

Rua Juraci Aletto, 224 - Galpão B - Sertãozinho - Mauá - SP
Fone: (11) 2137-7300 | www.alindustria.com.br



FERRAMENTAS NECESSÁRIAS (NÃO COMPÕE OS KITS)



ORIENTAÇÕES TÉCNICAS (VIDRO 8mm)

CÁLCULO DO VÃO - VIDRO FIXO E PORTA

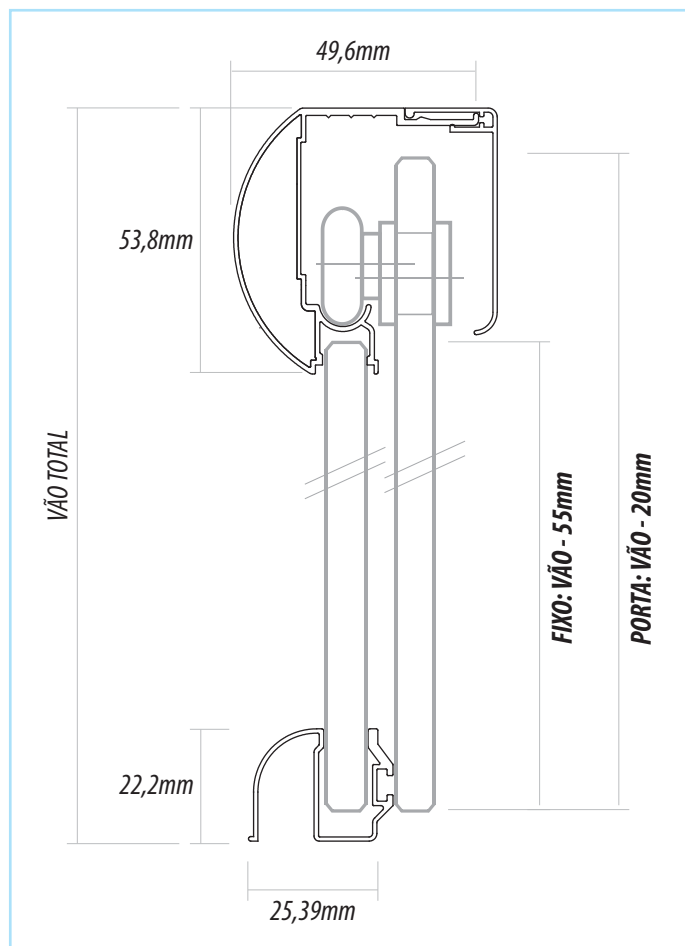

RECORTE ROLDANA

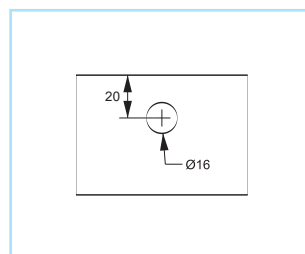

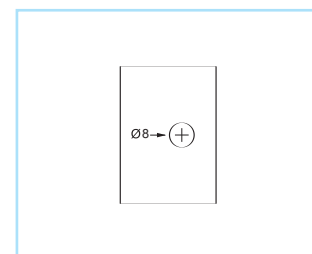

RECORTE PUXADOR



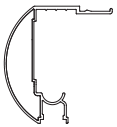

OBS: CORTAR O PERFIL "U" DE RECEBIMENTO (14mm), 50mm MENOR QUE A ALTURA DO BOX ACABADO.

PERFIS - KIT BOX F1

PERFIL: TRILHO SUPERIOR	
REFERÊNCIA	A
QUANTIDADE	1
	

PERFIL: CAPA	
REFERÊNCIA	B
QUANTIDADE	1
	

PERFIL: GUIA INFERIOR (CORRER)	
REFERÊNCIA	C
QUANTIDADE	1
	

PERFIL: CLICK	
REFERÊNCIA	D
QUANTIDADE	1
	

PERFIL: "U" (10,5mm)	
REFERÊNCIA	E
QUANTIDADE	1
	

PERFIL: "U" (14mm)	
REFERÊNCIA	F
QUANTIDADE	1
	

ACESSÓRIOS - KIT BOX F1

FIXADOR LATERAL	
REFERÊNCIA	K
QUANTIDADE	2
	

CUNHA FIXADOR LATERAL	
REFERÊNCIA	L
QUANTIDADE	2
	

BATEDOR SUPERIOR	
REFERÊNCIA	M
QUANTIDADE	1
	

ROLDANA EXCÊNTRICA C/ ROLAMENTO	
REFERÊNCIA	N
QUANTIDADE	2
	

GUIA INFERIOR	
REFERÊNCIA	O
QUANTIDADE	1
	

CUNHA	
REFERÊNCIA	P
QUANTIDADE	2
	

BATEDOR INFERIOR	
REFERÊNCIA	Q
QUANTIDADE	1
	

PARAFUSO DO BATEDOR INFERIOR	
REFERÊNCIA	R
QUANTIDADE	1
	

ESCOVINHA	
REFERÊNCIA	S
QUANTIDADE	1
	
OBS: APLICAÇÃO (OPCIONAL) É FEITA NO TRILHO INFERIOR	

BATEDOR DO VIDRO	
REFERÊNCIA	T
QUANTIDADE	2
	

PUXADOR BOX	
REFERÊNCIA	U
QUANTIDADE	1
	

ACABAMENTO LATERAL	
REFERÊNCIA	V
QUANTIDADE	2
	

PARAFUSO COM BUCHA	
REFERÊNCIA	W
QUANTIDADE	4
	

REBITE	
REFERÊNCIA	X
QUANTIDADE	4
	



MARCA DA QUALIDADE

/Ferragens / Alumínio / Puxadores

Rua Juraci Aletto, 224 - Galpão B - Sertãozinho - Mauá - SP
Fone: (11) 2137-7300 | www.alindustria.com.br



INSTALAÇÃO - KIT BOX F1 (VISÃO DE DENTRO PARA FORA)

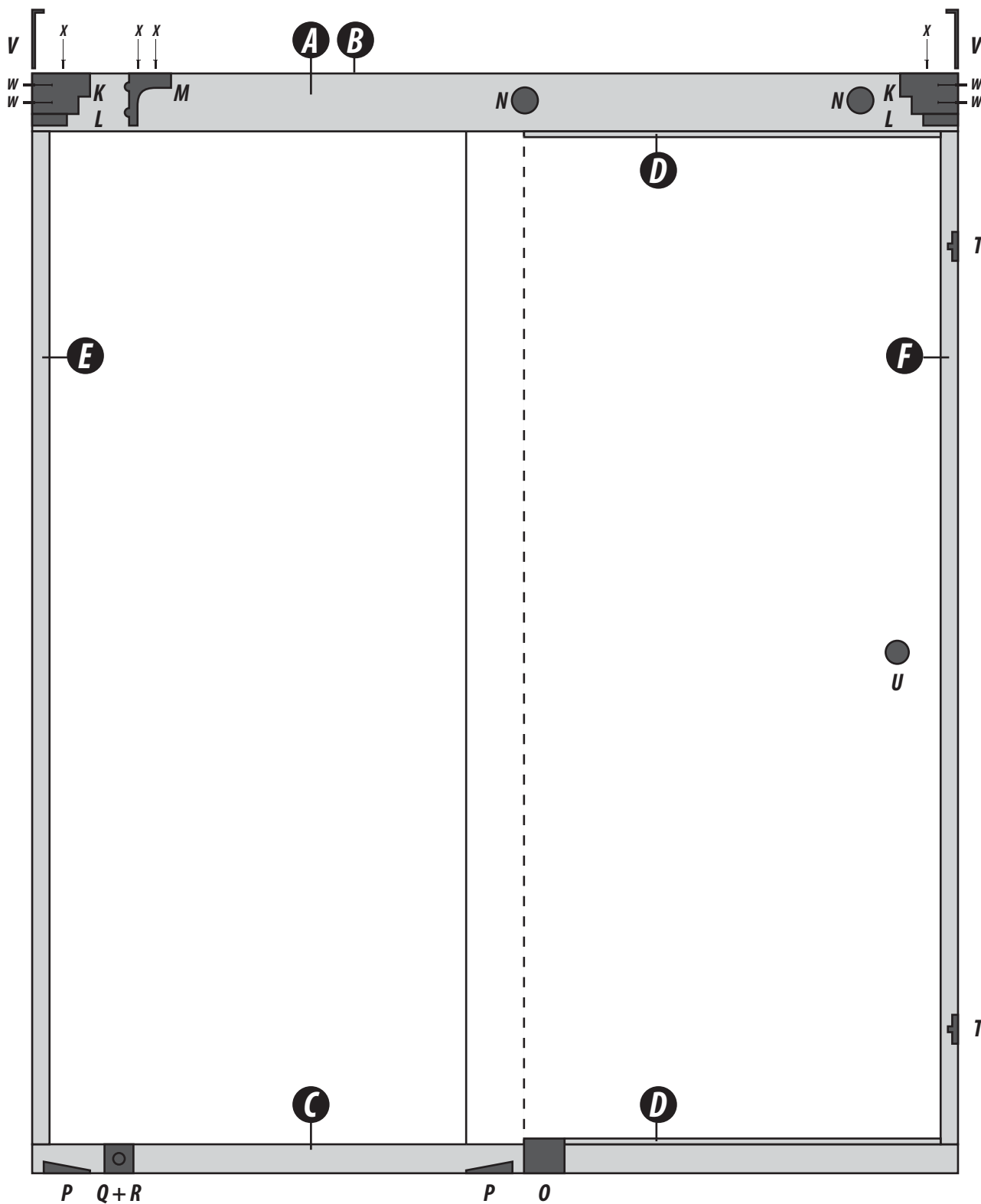



MARCA DA QUALIDADE

/Ferragens / Alumínio / Puxadores

Rua Juraci Aletto, 224 - Galpão B - Sertãozinho - Mauá - SP
Fone: (11) 2137-7300 | www.alindustria.com.br



PERFIS - KIT BOX F2

PERFIL: TRILHO SUPERIOR	
REFERÊNCIA	A
QUANTIDADE	1

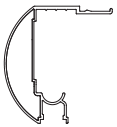

PERFIL: CAPA	
REFERÊNCIA	B
QUANTIDADE	1



PERFIL: GUIA INFERIOR (CORRER)	
REFERÊNCIA	C
QUANTIDADE	1



PERFIL: CLICK	
REFERÊNCIA	D
QUANTIDADE	1



PERFIL: "U" (10,5mm)	
REFERÊNCIA	E
QUANTIDADE	2



ACESSÓRIOS - KIT BOX F2

FIXADOR LATERAL	
REFERÊNCIA	K
QUANTIDADE	2



CUNHA FIXADOR LATERAL	
REFERÊNCIA	L
QUANTIDADE	2



BATEDOR SUPERIOR	
REFERÊNCIA	M
QUANTIDADE	2



ROLDANA EXCÊNTRICA C/ ROLAMENTO	
REFERÊNCIA	N
QUANTIDADE	2



GUIA INFERIOR	
REFERÊNCIA	O
QUANTIDADE	1



CUNHA	
REFERÊNCIA	P
QUANTIDADE	4



BATEDOR INFERIOR	
REFERÊNCIA	Q
QUANTIDADE	2



PARAFUSO DO BATEDOR INFERIOR	
REFERÊNCIA	R
QUANTIDADE	2



ESCOVINHA	
REFERÊNCIA	S
QUANTIDADE	1



OBS: APLICAÇÃO (OPCIONAL) É FEITA NO TRILHO INFERIOR

PUXADOR BOX	
REFERÊNCIA	U
QUANTIDADE	1



ACABAMENTO LATERAL	
REFERÊNCIA	V
QUANTIDADE	2



PARAFUSO COM BUCHA	
REFERÊNCIA	W
QUANTIDADE	4



REBITE	
REFERÊNCIA	X
QUANTIDADE	6





MARCA DA QUALIDADE

/Ferragens / Alumínio / Puxadores

Rua Juraci Aletto, 224 - Galpão B - Sertãozinho - Mauá - SP
Fone: (11) 2137-7300 | www.alindustria.com.br



INSTALAÇÃO - KIT BOX F2 (VISÃO DE DENTRO PARA FORA)

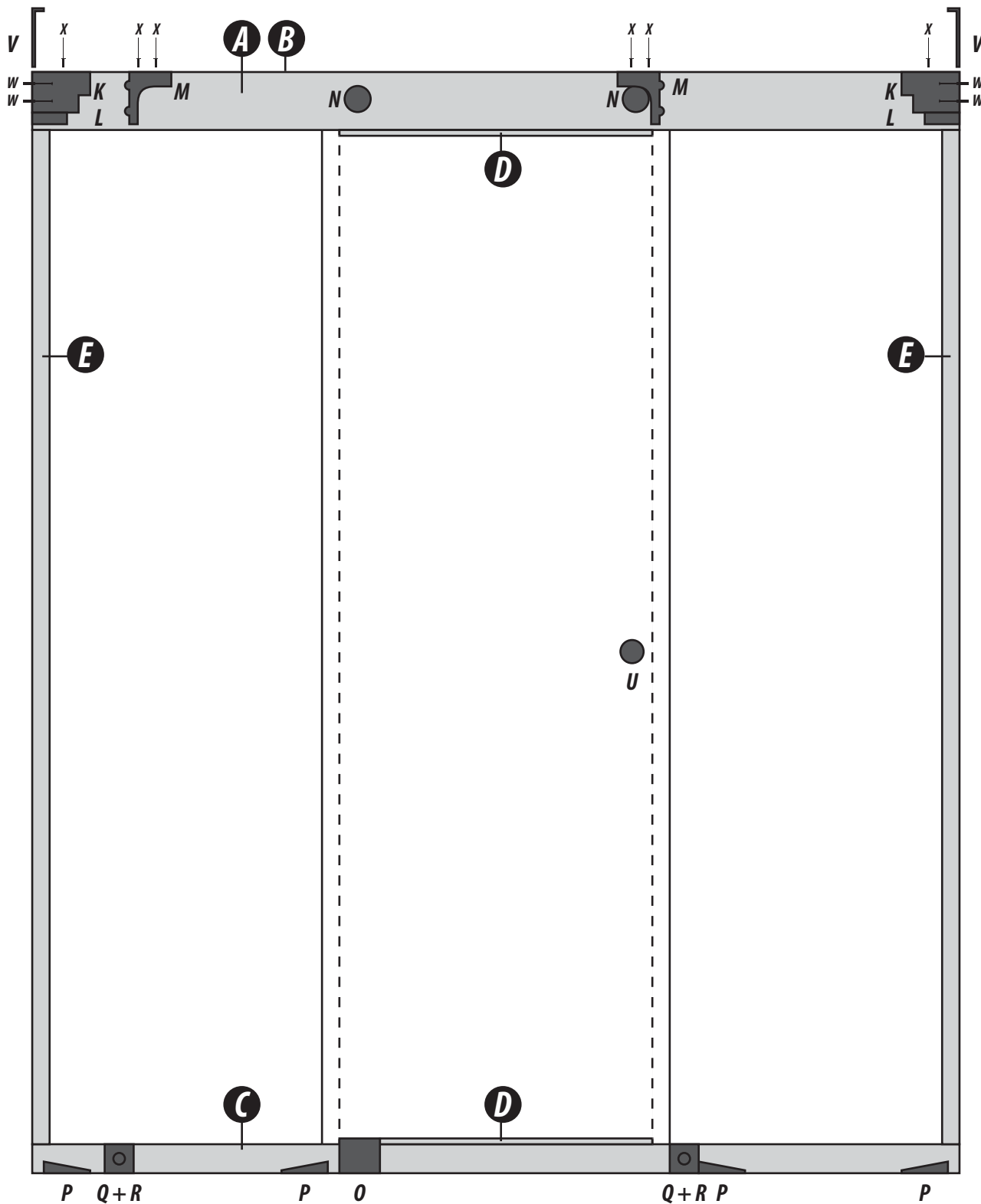

PERFIS - KIT BOX F3

PERFIL: TRILHO SUPERIOR	
REFERÊNCIA	A
QUANTIDADE	1

PERFIL: CAPA	
REFERÊNCIA	B
QUANTIDADE	1

PERFIL: GUIA INFERIOR (CORRER)	
REFERÊNCIA	C
QUANTIDADE	1

PERFIL: CLICK	
REFERÊNCIA	D
QUANTIDADE	1

PERFIL: "U" (10,5mm)	
REFERÊNCIA	E
QUANTIDADE	2

PERFIL: VEDAÇÃO (S/TRANSPASSE)	
REFERÊNCIA	I
QUANTIDADE	1

ACESSÓRIOS - KIT BOX F3

FIXADOR LATERAL	
REFERÊNCIA	K
QUANTIDADE	2

CUNHA FIXADOR LATERAL	
REFERÊNCIA	L
QUANTIDADE	2

BATEDOR SUPERIOR	
REFERÊNCIA	M
QUANTIDADE	4

ROLDANA EXCÊNTRICA C/ ROLAMENTO	
REFERÊNCIA	N
QUANTIDADE	4

GUIA INFERIOR	
REFERÊNCIA	O
QUANTIDADE	2

CUNHA	
REFERÊNCIA	P
QUANTIDADE	4

BATEDOR INFERIOR	
REFERÊNCIA	Q
QUANTIDADE	2

PARAFUSO DO BATEDOR INFERIOR	
REFERÊNCIA	R
QUANTIDADE	2

ESCOVINHA	
REFERÊNCIA	S
QUANTIDADE	2
 <small>OBS: APLICAÇÃO (OPCIONAL) É FEITA NO TRILHO INFERIOR</small>	

PUXADOR BOX	
REFERÊNCIA	U
QUANTIDADE	2

ACABAMENTO LATERAL	
REFERÊNCIA	V
QUANTIDADE	2

PARAFUSO COM BUCHA	
REFERÊNCIA	W
QUANTIDADE	4

REBITE	
REFERÊNCIA	X
QUANTIDADE	10



MARCA DA QUALIDADE

/Ferragens / Alumínio / Puxadores

Rua Juraci Aletto, 224 - Galpão B - Sertãozinho - Mauá - SP
Fone: (11) 2137-7300 | www.alindustria.com.br



INSTALAÇÃO - KIT BOX F3 (VISÃO DE DENTRO PARA FORA)

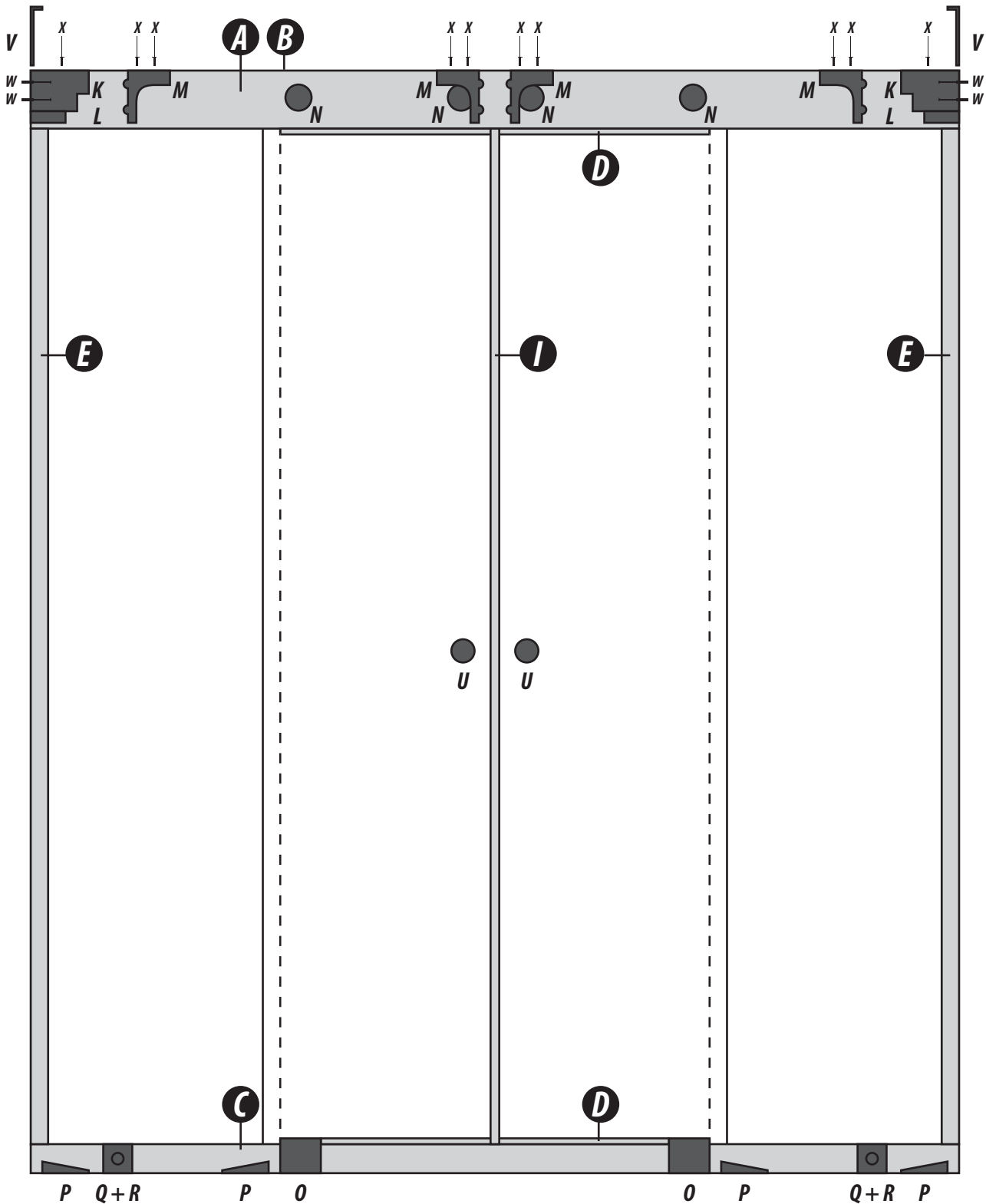

PERFIS - KIT BOX CANTO

PERFIL: TRILHO SUPERIOR	
REFERÊNCIA	A
QUANTIDADE	1

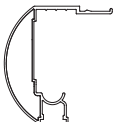

PERFIL: CAPA	
REFERÊNCIA	B
QUANTIDADE	1



PERFIL: GUIA INFERIOR (CORRER)	
REFERÊNCIA	C
QUANTIDADE	1



PERFIL: CLICK	
REFERÊNCIA	D
QUANTIDADE	1



PERFIL: "U" (10,5mm)	
REFERÊNCIA	E
QUANTIDADE	2



PERFIL: CANTO	
REFERÊNCIA	G
QUANTIDADE	1



ACESSÓRIOS - KIT BOX CANTO

FIXADOR LATERAL	
REFERÊNCIA	K
QUANTIDADE	2



CUNHA FIXADOR LATERAL	
REFERÊNCIA	L
QUANTIDADE	2



BATEDOR SUPERIOR	
REFERÊNCIA	M
QUANTIDADE	4



ROLDANA EXCÊNTRICA C/ ROLAMENTO	
REFERÊNCIA	N
QUANTIDADE	4



GUIA INFERIOR	
REFERÊNCIA	O
QUANTIDADE	2



CUNHA	
REFERÊNCIA	P
QUANTIDADE	4



BATEDOR INFERIOR	
REFERÊNCIA	Q
QUANTIDADE	2



PARAFUSO DO BATEDOR INFERIOR	
REFERÊNCIA	R
QUANTIDADE	2



ESCOVINHA	
REFERÊNCIA	S
QUANTIDADE	2



OBS: APLICAÇÃO (OPCIONAL) É FEITA NO TRILHO INFERIOR

PUXADOR BOX	
REFERÊNCIA	U
QUANTIDADE	2



ACABAMENTO LATERAL	
REFERÊNCIA	V
QUANTIDADE	2



PARAFUSO COM BUCHA	
REFERÊNCIA	W
QUANTIDADE	4



REBITE	
REFERÊNCIA	X
QUANTIDADE	10



JOELHO GRANDE	
REFERÊNCIA	Y
QUANTIDADE	1



JOELHO PEQUENO	
REFERÊNCIA	Z
QUANTIDADE	1





MARCA DA QUALIDADE

/Ferragens / Alumínio / Puxadores

Rua Juraci Aletto, 224 - Galpão B - Sertãozinho - Mauá - SP
Fone: (11) 2137-7300 | www.alindustria.com.br



INSTALAÇÃO - KIT BOX CANTO (VISÃO DE DENTRO PARA FORA)

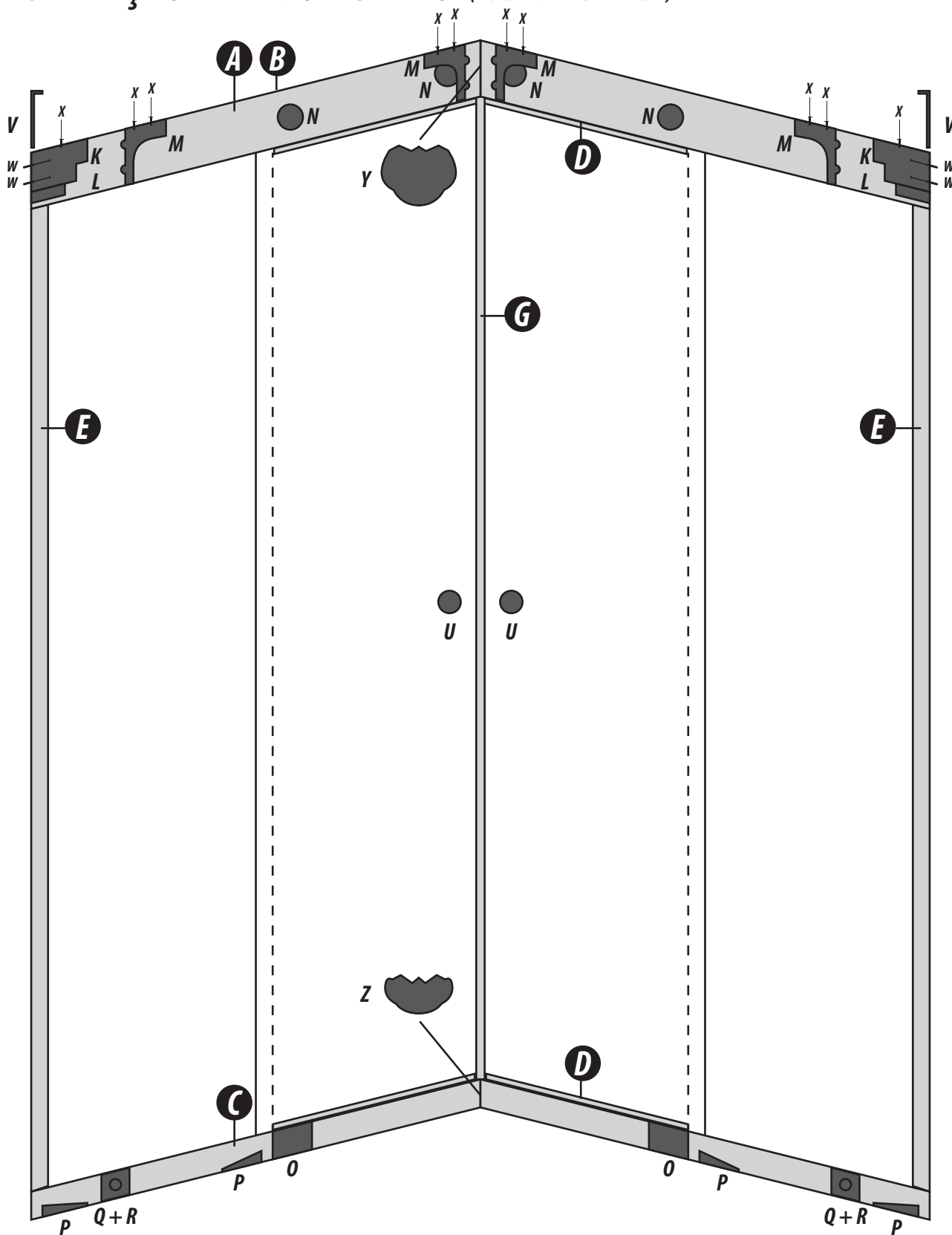



MARCA DA QUALIDADE

/Ferragens / Alumínio / Puxadores

Rua Juraci Aletto, 224 - Galpão B - Sertãozinho - Mauá - SP
Fone: (11) 2137-7300 | www.alindustria.com.br



PERFIS - KIT BOX DE ABRIR COM TRANSPASSE

PERFIL: GUIA INFERIOR (CORRER)	
REFERÊNCIA C	
QUANTIDADE 1	

PERFIL: CLICK	
REFERÊNCIA D	
QUANTIDADE 1	

PERFIL: "U" (10,5mm)	
REFERÊNCIA E	
QUANTIDADE 1	

PERFIL: VEDAÇÃO (C/ TRANSPASSE)	
REFERÊNCIA H	
QUANTIDADE 1	

ACESSÓRIOS - KIT BOX DE ABRIR COM TRANSPASSE

CUNHA	
REFERÊNCIA P	
QUANTIDADE 2	

ESCOVINHA	
REFERÊNCIA S	
QUANTIDADE 2	OBS: ESCOVINHA JÁ APLICADA NOS PERFIS: REFERÊNCIAS "C" E "H"

PUXADOR BOX	
REFERÊNCIA U	
QUANTIDADE 1	

PARAFUSO COM BUCHA	
REFERÊNCIA W	
QUANTIDADE 3	



MARCA DA QUALIDADE

/Ferragens /Alumínio /Puxadores

Rua Juraci Aletto, 224 - Galpão B - Sertãozinho - Mauá - SP
Fone: (11) 2137-7300 | www.alindustria.com.br



INSTALAÇÃO - KIT BOX DE ABRIR COM TRANSPASSE (VISÃO DE DENTRO PARA FORA)

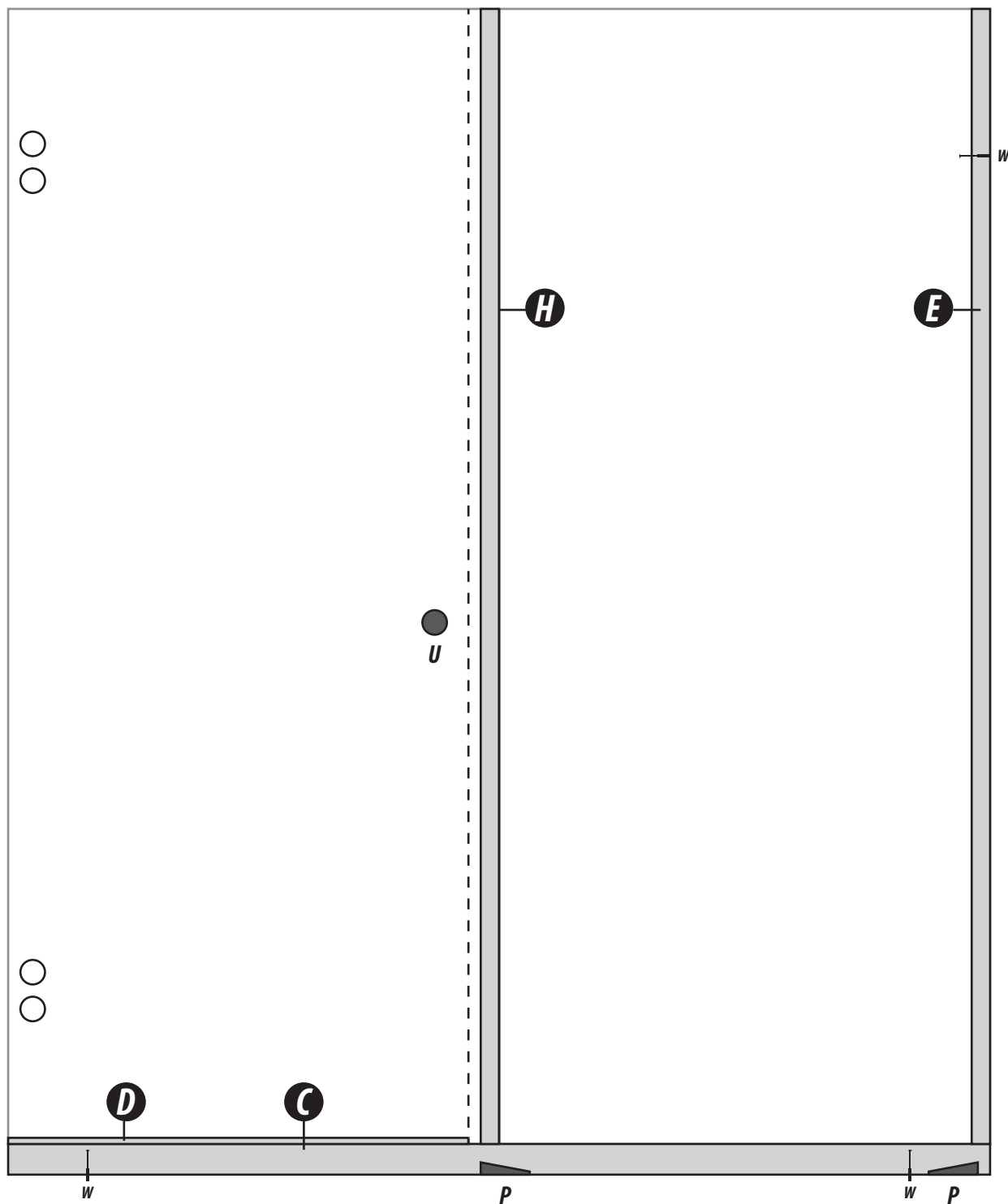



MARCA DA QUALIDADE

/Ferragens / Alumínio / Puxadores

Rua Juraci Aletto, 224 - Galpão B - Sertãozinho - Mauá - SP
Fone: (11) 2137-7300 | www.alindustria.com.br

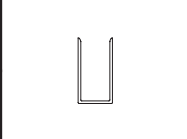

PERFIS - KIT BOX DE ABRIR SEM TRANSPASSE

PERFIL: "U" (10,5mm)	
REFERÊNCIA E	
QUANTIDADE 2	

PERFIL: VEDAÇÃO (S/ TRANSPASSE)	
REFERÊNCIA I	
QUANTIDADE 1	

PERFIL: GUIA INFERIOR (S/ TRANSPASSE)	
REFERÊNCIA J	
QUANTIDADE 1	

ACESSÓRIOS - KIT BOX DE ABRIR SEM TRANSPASSE

CUNHA	
REFERÊNCIA P	
QUANTIDADE 2	

ESCOVINHA	
REFERÊNCIA S	
QUANTIDADE 2	OBS: ESCOVINHA JÁ APLICADA NOS PERFIS: REFERÊNCIAS "I" E "J"

PUXADOR BOX	
REFERÊNCIA U	
QUANTIDADE 1	

PARAFUSO COM BUCHA	
REFERÊNCIA W	
QUANTIDADE 3	



MARCA DA QUALIDADE

/Ferragens /Alumínio /Puxadores

Rua Juraci Aletto, 224 - Galpão B - Sertãozinho - Mauá - SP
Fone: (11) 2137-7300 | www.alindustria.com.br



INSTALAÇÃO - KIT BOX DE ABRIR SEM TRANSPASSE (VISÃO DE DENTRO PARA FORA)

